



Gatwick Airport Northern Runway Project

Environmental Statement

Appendix 8.8.1: Outline Landscape and Ecology Management Plan - Part 4

Book 5

VERSION: 1.0

DATE: JULY 2023

Application Document Ref: 5.3

PINS Reference Number: TR020005



Legend

- Site Boundary
 - Indicative temporary protective fence in accordance with Section 6.2. BS5837:2012. See below for example barriers.
 - Tree loss required for construction
 - Tree with numbered reference. Canopy spread and BS5837:2012 tree quality category as shown below.
 - Tree off-site with numbered reference. Canopy spread and BS5837:2012 tree quality category.
 - Vegetation group with numbered reference. Canopy extents and BS5837:2012 tree quality category as shown below.
 - Hedge with numbered reference. Width and BS5837:2012 tree quality category as shown below.
- BS 5837:2012 Tree Quality Categories - Table 1**
- Category A - High quality
 - Category B - Moderate quality
 - Category C - Low quality
 - Category U - Unsuitable for retention

NOTE:
 • Refer to RPS Tree Survey Report & Schedule for further details.

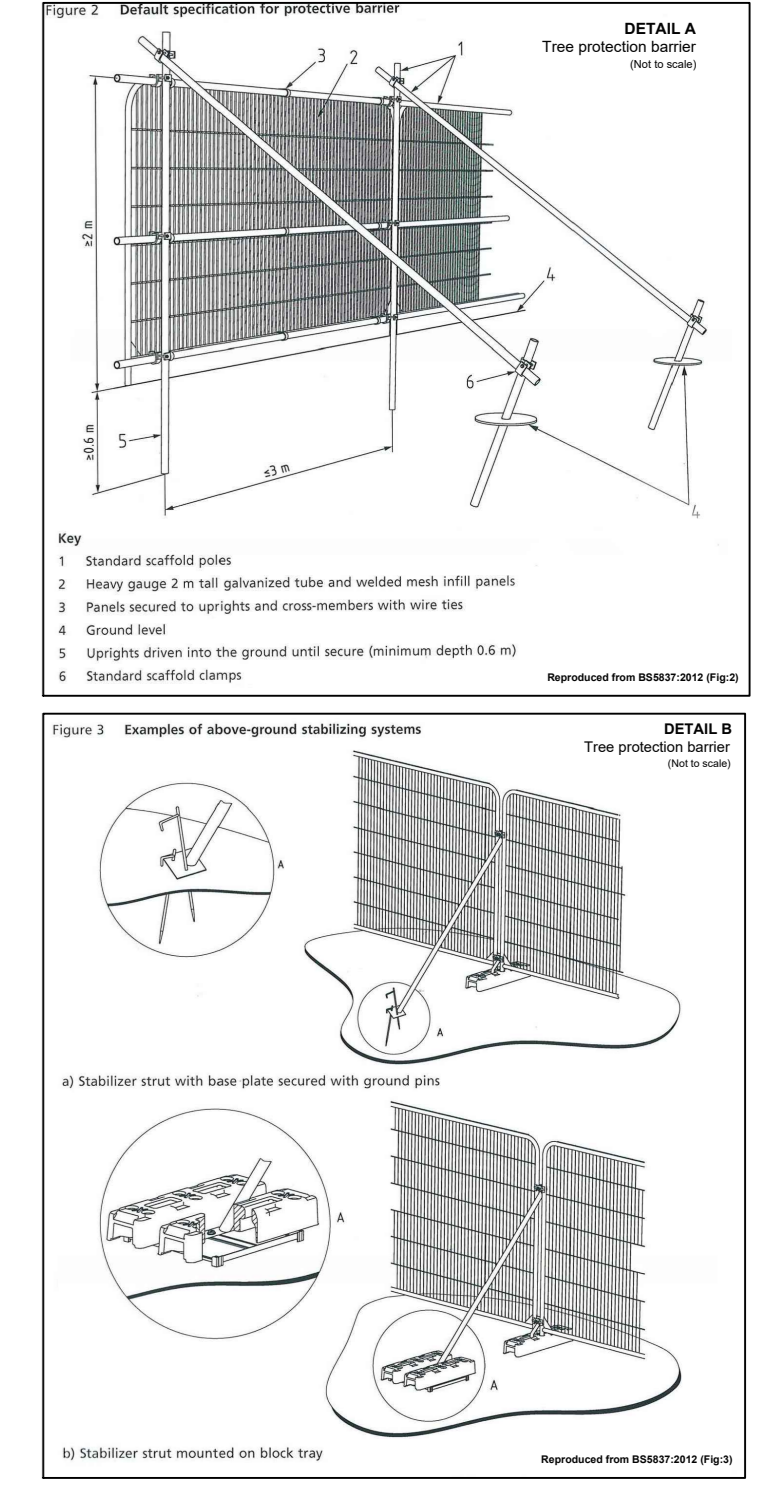

Key Plan

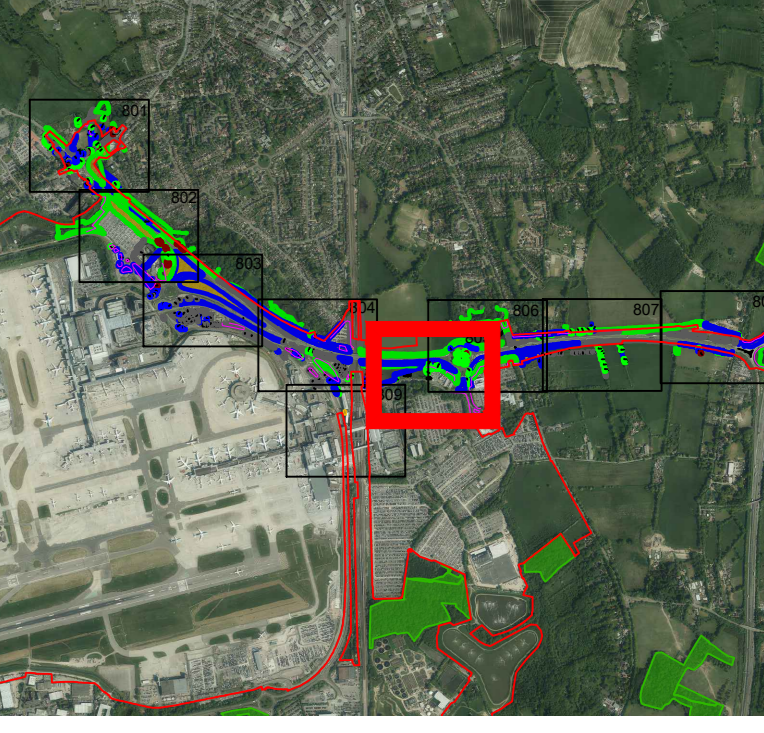

DOCUMENT
Environmental Statement

DRAWING TITLE
Surface Access Tree Removal and Protection Plan
 Appendix 8.8.1 Annex 4
 Sheet 5 of 9

DATE
 July 2023

ORIENTATION N	DRAWING NO. 805	REVISION For ES Issue
	DRAWN BY RC	PM / CHECKED BY DC

SCALE @ A0
 0 25 50 m

Reproduced from Ordnance Survey map with the permission of Ordnance Survey on behalf of the controller of Her Majesty's Stationery Office © Crown Copyright (2023). License number 0100031673, 100048492.
 © Copyright 2023 Gatwick Airport Limited. No part of this drawing is to be reproduced without prior permission of Gatwick Airport Limited.



Legend

- Site Boundary
 - Indicative temporary protective fence in accordance with Section 6.2.1 of BS5837:2012. See below for example barriers.
 - Tree loss required for construction
 - Tree with numbered reference. Canopy spread and BS5837:2012 tree quality category as shown below.
 - T1*
 - Tree off-site with numbered reference. Canopy spread and BS5837:2012 tree quality category.
 - G1
 - Hedge with numbered reference. Width and BS5837:2012 tree quality category as shown below.
 - H1
- BS 5837:2012 Tree Quality Categories - Table 1
- Category A - High quality
 - Category B - Moderate quality
 - Category C - Low quality
 - Category U - Unsuitable for retention

NOTE:
 • Refer to RPS Tree Survey Report & Schedule for further details.

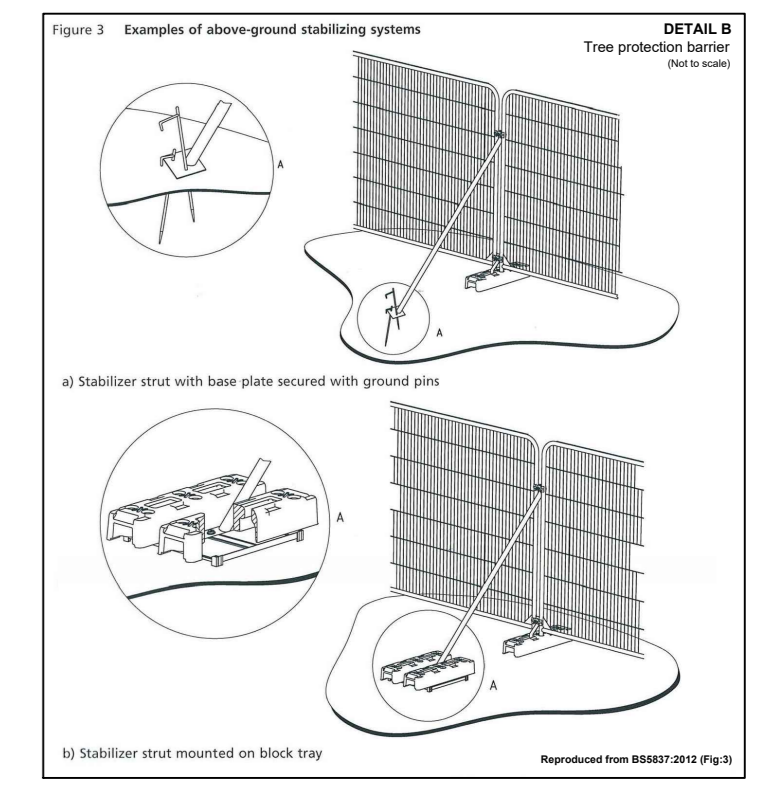
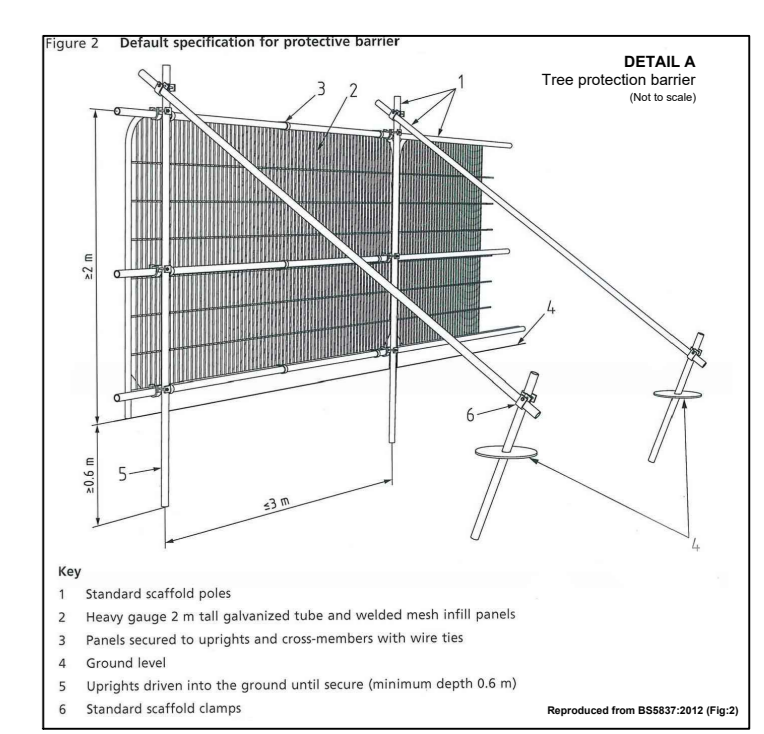

Key Plan

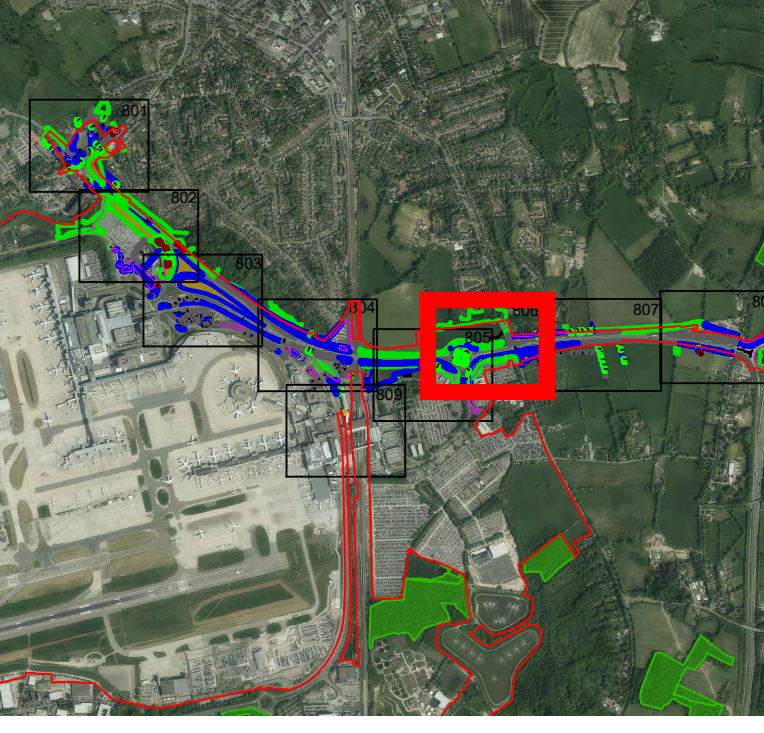

DOCUMENT
Environmental Statement

DRAWING TITLE
Surface Access Tree Removal and Protection Plan
 Appendix 8.8.1 Annex 4
 Sheet 6 of 9

DATE
 July 2023

ORIENTATION N	DRAWING NO. 806	REVISION For ES Issue
	DRAWN BY RC	PM / CHECKED BY DC

SCALE @ A0
 0 25 50 m

Reproduced from Ordnance Survey map with the permission of Ordnance Survey on behalf of the controller of Her Majesty's Stationery Office © Crown Copyright (2023). License number 6100031673, 10001998, 100048492.
 © Copyright 2023 Gatwick Airport Limited. No part of this drawing is to be reproduced without prior permission of Gatwick Airport Limited.



Legend

- Site Boundary
 - Indicative temporary protective fence in accordance with Section 6.2 - BS5837:2012. See below for example barriers.
 - Tree loss required for construction
 - Tree with numbered reference. Canopy spread and BS5837:2012 tree quality category as shown below.
 - Tree off-site with numbered reference. Canopy spread and BS5837:2012 tree quality category.
 - Vegetation group with numbered reference. Canopy extents and BS5837:2012 tree quality category as shown below.
 - Hedge with numbered reference. Width and BS5837:2012 tree quality category as shown below.
- BS 5837:2012 Tree Quality Categories - Table 1**
- Category A - High quality
 - Category B - Moderate quality
 - Category C - Low quality
 - Category U - Unsuitable for retention

NOTE:
 • Refer to RPS Tree Survey Report & Schedule for further details.

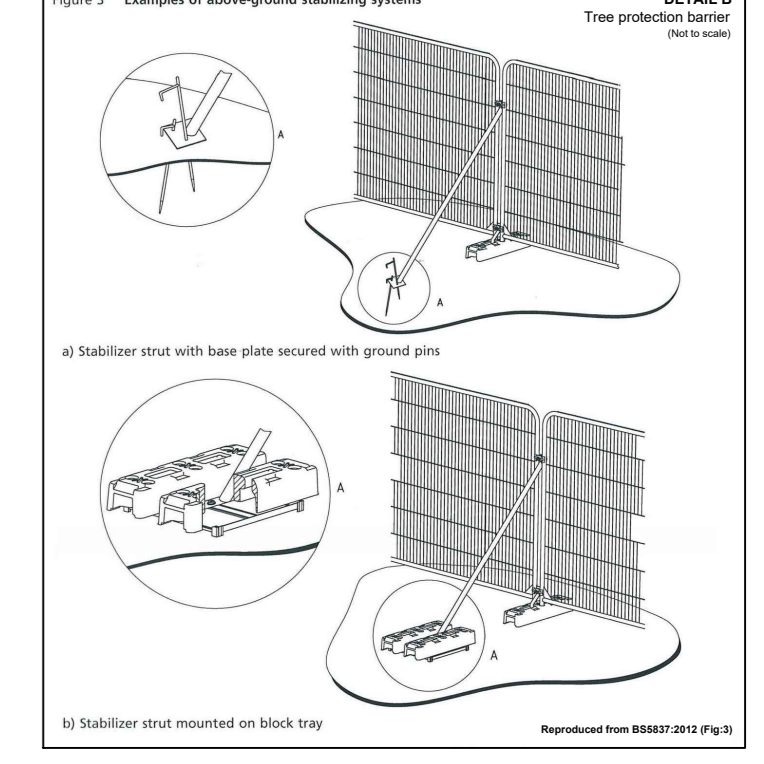
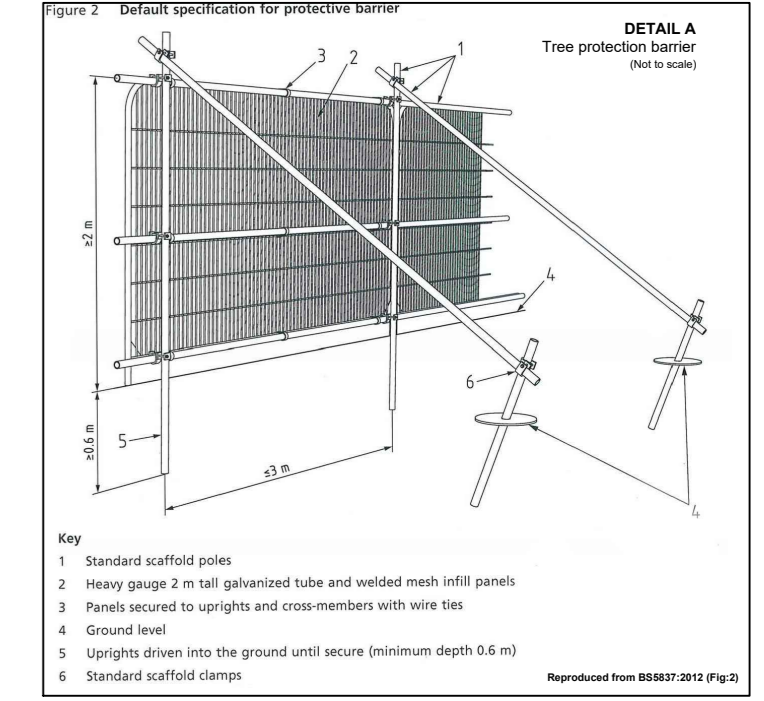

Key Plan

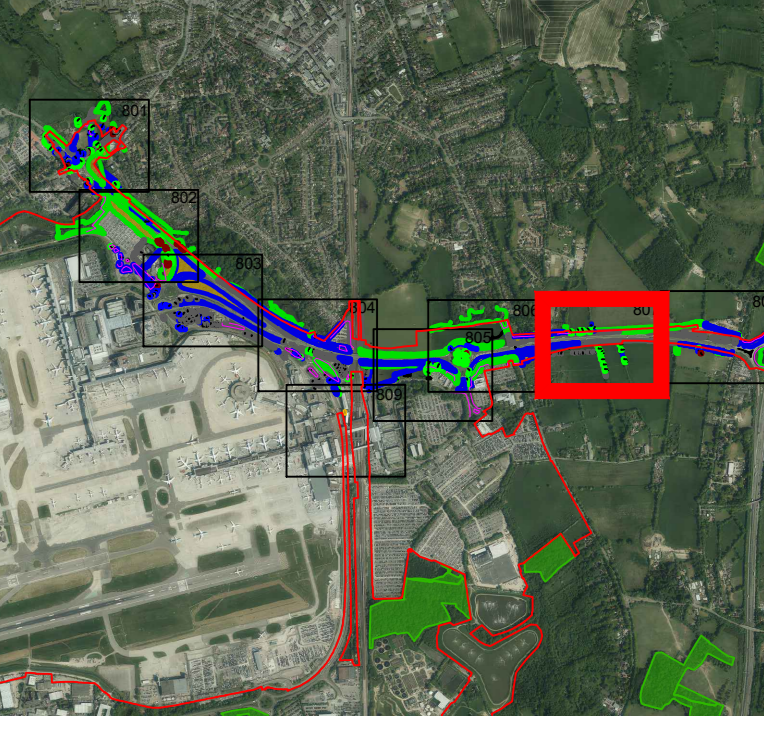

DOCUMENT
Environmental Statement

DRAWING TITLE
Surface Access Tree Removal and Protection Plan
 Appendix 8.8.1 Annex 4
 Sheet 7 of 9

DATE
 July 2023



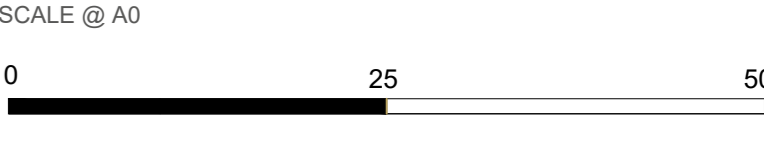





ORIENTATION N	DRAWING NO. 807	REVISION For ES Issue
	DRAWN BY RC	PM / CHECKED BY DC



Reproduced from Ordnance Survey map with the permission of Ordnance Survey on behalf of the controller of Her Majesty's Stationery Office © Crown Copyright (2023). License number 0100031673, 100048492.
 © Copyright 2023 Gatwick Airport Limited. No part of this drawing is to be reproduced without prior permission of Gatwick Airport Limited.

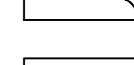
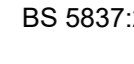

Legend

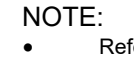
-  Site Boundary
 -  Indicative temporary protective fence line in accordance with Section 6.2.1 of BS5837:2012. See below for example barriers.
 -  Tree loss required for construction
 -  Tree with numbered reference. Canopy spread and BS5837:2012 tree quality category as shown below.
 -  Tree off-site with numbered reference. Canopy spread and BS5837:2012 tree quality category.
 -  Vegetation group with numbered reference. Canopy extents and BS5837:2012 tree quality category as shown below.
 -  Hedge with numbered reference. Width and BS5837:2012 tree quality category as shown below.
- BS 5837:2012 Tree Quality Categories - Table 1
-  Category A - High quality
 -  Category B - Moderate quality
 -  Category C - Low quality
 -  Category U - Unsuitable for retention

NOTE:
 • Refer to RPS Tree Survey Report & Schedule for further details.

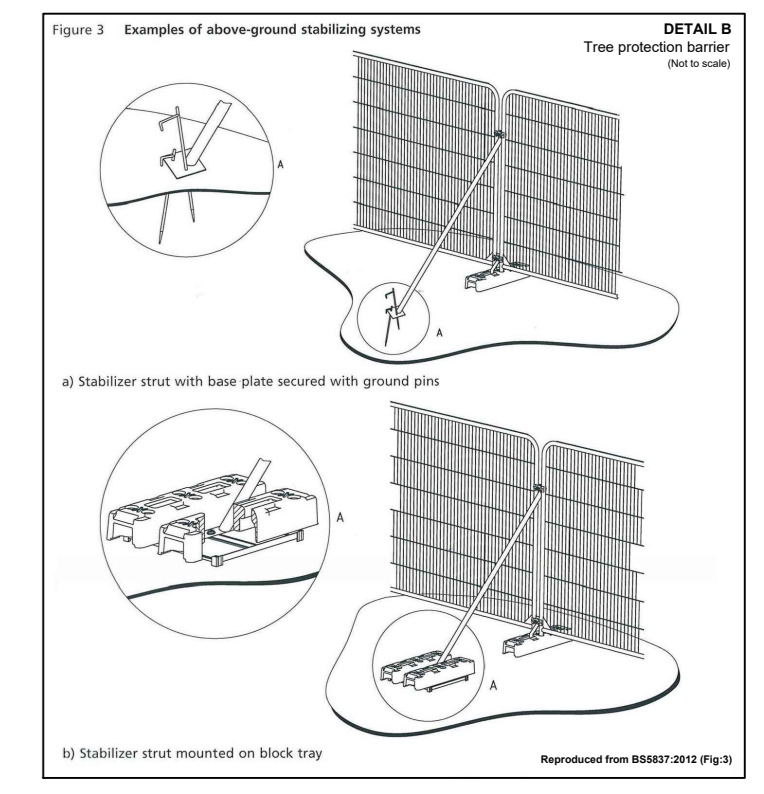
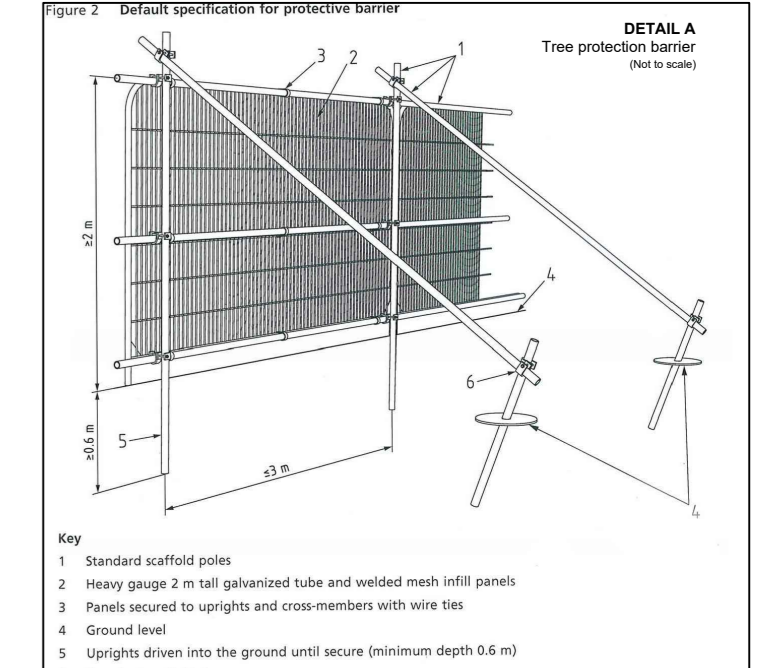

Key Plan

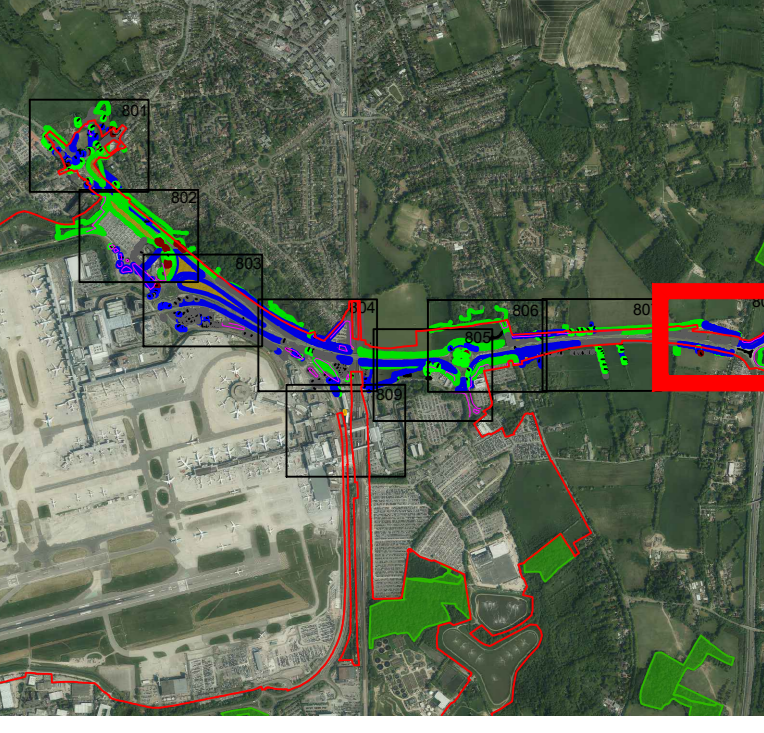

DOCUMENT
 Environmental Statement

DRAWING TITLE
Surface Access Tree Removal and Protection Plan
 Appendix 8.8.1 Annex 4
 Sheet 8 of 9

DATE
 July 2023

ORIENTATION N	DRAWING NO. 808	REVISION For ES Issue
	DRAWN BY RC	PM / CHECKED BY DC

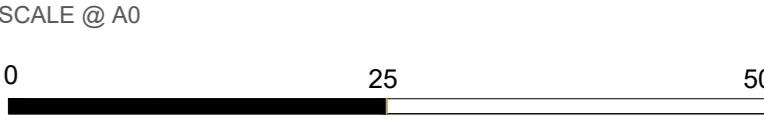

Reproduced from Ordnance Survey map with the permission of Ordnance Survey on behalf of the controller of Her Majesty's Stationery Office © Crown Copyright (2023). License number 0100031673, 10001998, 100048492.
 © Copyright 2023 Gatwick Airport Limited. No part of this drawing is to be reproduced without prior permission of Gatwick Airport Limited.



Legend

- Site Boundary
 - Indicative temporary protective fencing in accordance with Section 6.2. BS5837:2012. See below for example barriers.
 - Tree loss required for construction
 - Tree with numbered reference. Canopy spread and BS5837:2012 tree quality category as shown below.
 - T1F
 - Tree off-site with numbered reference. Canopy spread and BS5837:2012 tree quality category.
 - Vegetation group with numbered reference. Canopy extents and BS5837:2012 tree quality category as shown below.
 - G1
 - Hedge with numbered reference. Width and BS5837:2012 tree quality category as shown below.
 - H1
- BS 5837:2012 Tree Quality Categories - Table 1**
- Category A - High quality
 - Category B - Moderate quality
 - Category C - Low quality
 - Category U - Unsuitable for retention

NOTE:
 • Refer to RPS Tree Survey Report & Schedule for further details.

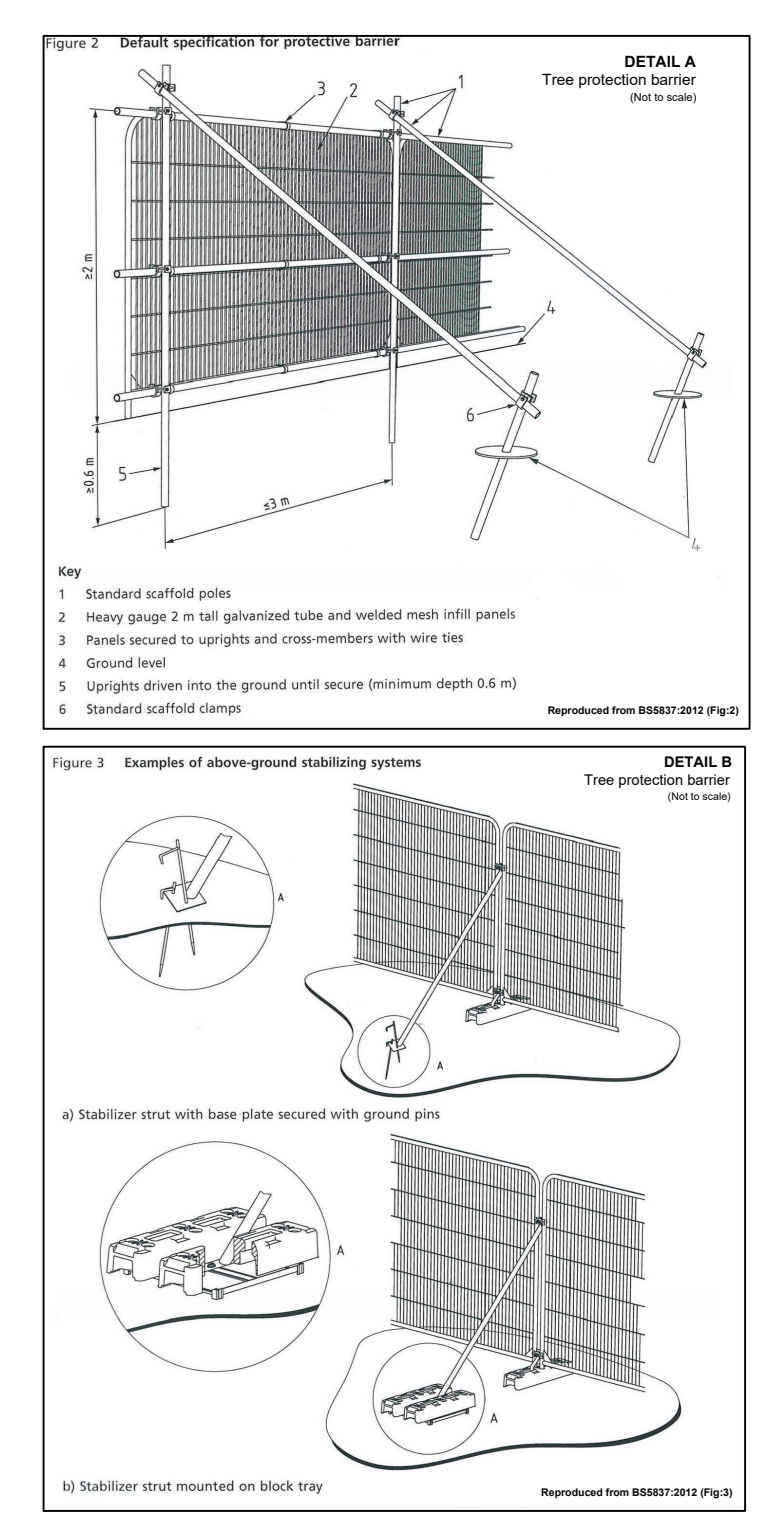

Key Plan



DOCUMENT
 Environmental Statement

DRAWING TITLE
 Surface Access Tree Removal and Protection Plan
 Appendix 8.8.1 Annex 4
 Sheet 9 of 9

DATE
 July 2023

ORIENTATION N	DRAWING NO. 809	REVISION For ES Issue
	DRAWN BY RC	PM / CHECKED BY DC

SCALE @ A0
 0 25 50 m

Reproduced from Ordnance Survey map with the permission of Ordnance Survey on behalf of the controller of Her Majesty's Stationery Office © Crown Copyright (2023). License number 6100031673, 10001998, 10004862.
 © Copyright 2023 Gatwick Airport Limited. No part of this drawing is to be reproduced without prior permission of Gatwick Airport Limited.